

P-3 VISION

HYBRID LED
DIRECT VIEW
AND WASH
FIXTURE



 **SGM**[®]



LIGHT AND PIXELS

WITH THE POWER OF SGM

The P-3 Vision is the first fixture released in the new 3 series platform of SGM Light fixtures. This revolutionary family of fixtures introduces numerous features and performance improvements which makes it unique amongst fixtures in this size class.

Incorporating a direct view pixel grid together with a top-quality illumination LED engine, the P-3 Vision is a game-changer in entertainment lighting. With these two LED arrays integrated in the same fixture, a designer can use the direct view matrix as a 42mm pitch LED screen and a >12,700 lumen luminaire in one.

Arraying the P-3 Vision results in a stunningly powerful grid which brings together lighting and video pixel content like never before.

FEATURES

- 18 RGBW Illumination LEDs
- 28 Pixel Direct View LED Engine
- Over 13.000 peak Lumens on a 10 degree fixture
- DynaMix Scaling LED Drive System
- Fully Array-able Vertically and Horizontally
- 10°, 25°, or 35° native lensing
- 100-277VAC; 360 Watts Maximum
- DMX channels: 7 – 128
- IP66, 3G Vibration, IK09 Impact
- Wired/wireless DMX, sACN, Art-Net



Power, Ethernet, & DMX Connections

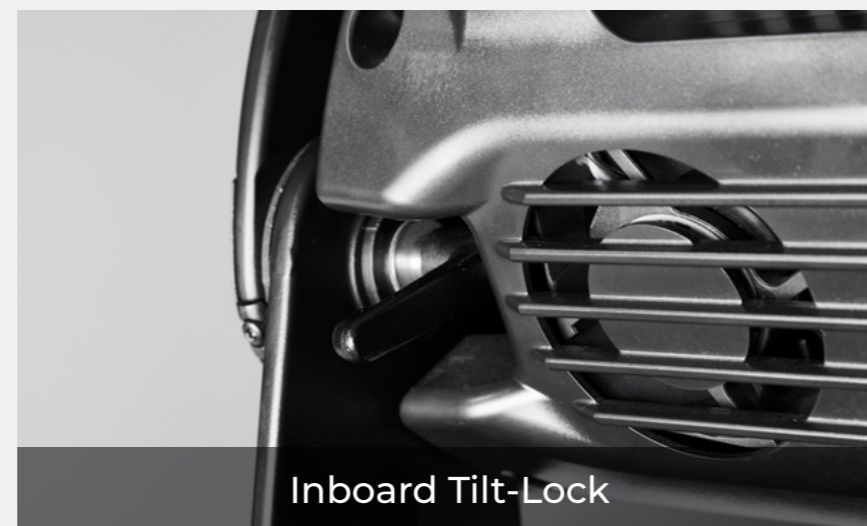

Inboard Tilt-Lock



OLED Display



Thin-Wall Bezel for Arraying

DIMENSION DRAWINGS

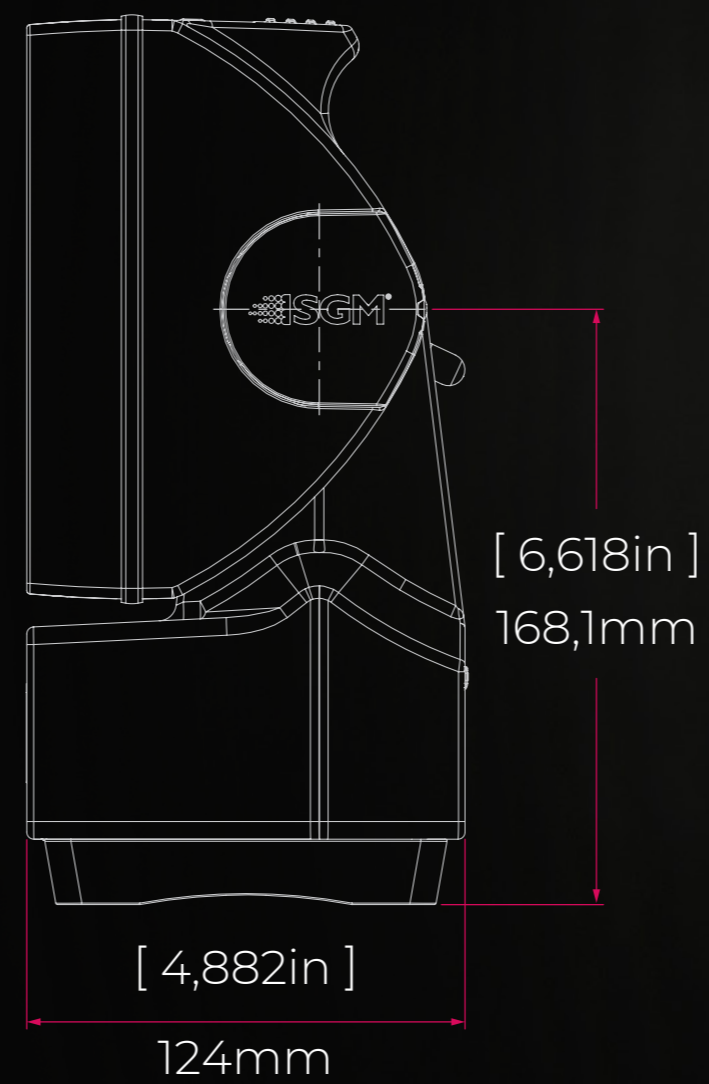
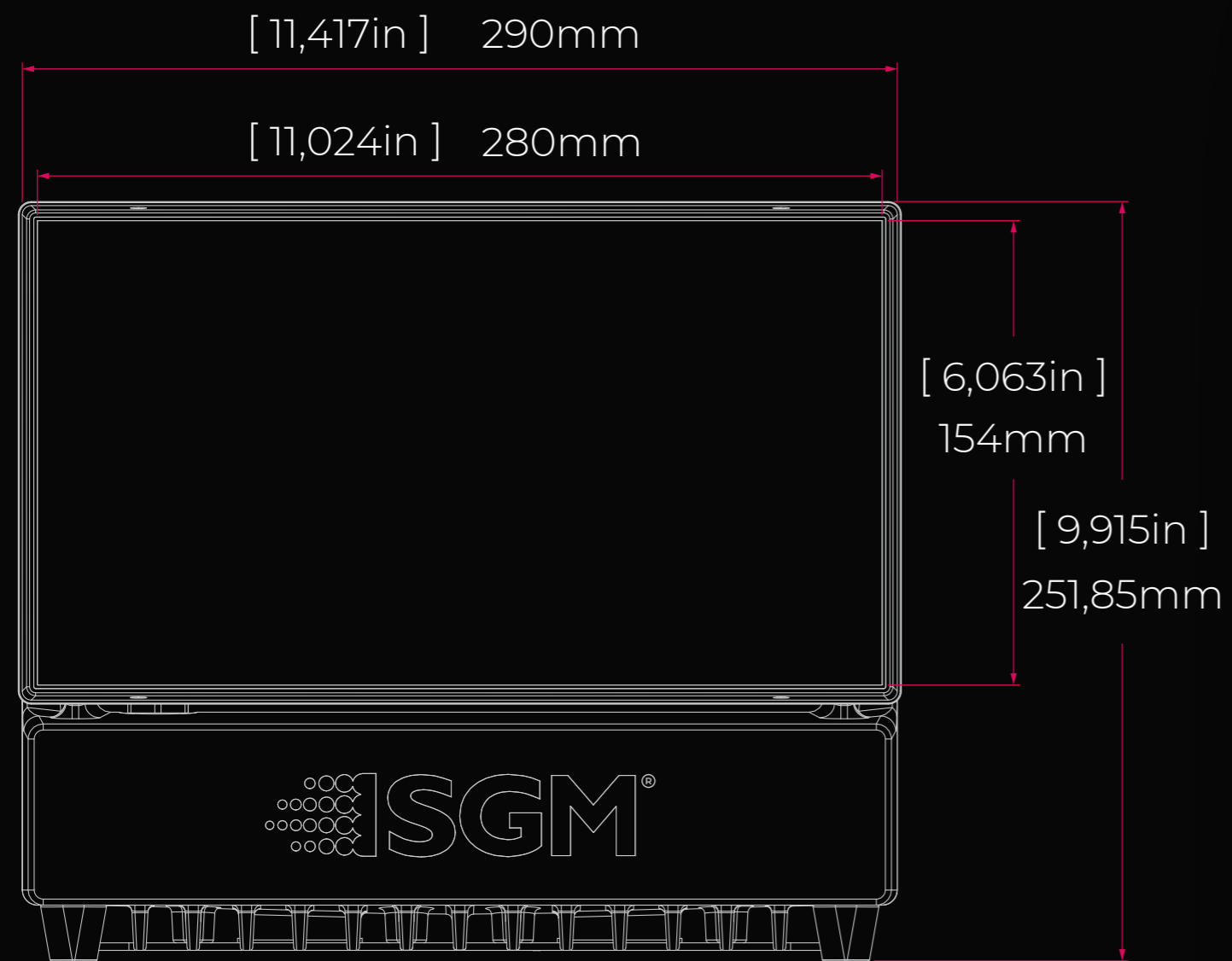

NEW VISION NEW POSSIBILITIES

The new Video Pixel matrix in the P-3 Vision is a 28 Pixel, 42mmx42mm LED array. Designed to produce standalone effects or be arrayed in grids and shapes with arraying accessories, the P-3 Vision is a new type of lighting AND video tool in one. The VP pixels are identical to the pixels in the SGM Light VPL series, and can run on the same data network. This allows P-3 Vision and VPL to be mixed and matched to provide multiple options and incredible design flexibility.

All SGM fixtures make use of SGM Light's industry leading calibration, TruColor. The calibration ensures that all LEDs are calibrated and matched to each other. This ensures that arraying the P-3 will result in a seamless result with no color aberrations.



ARRAY CLUSTER

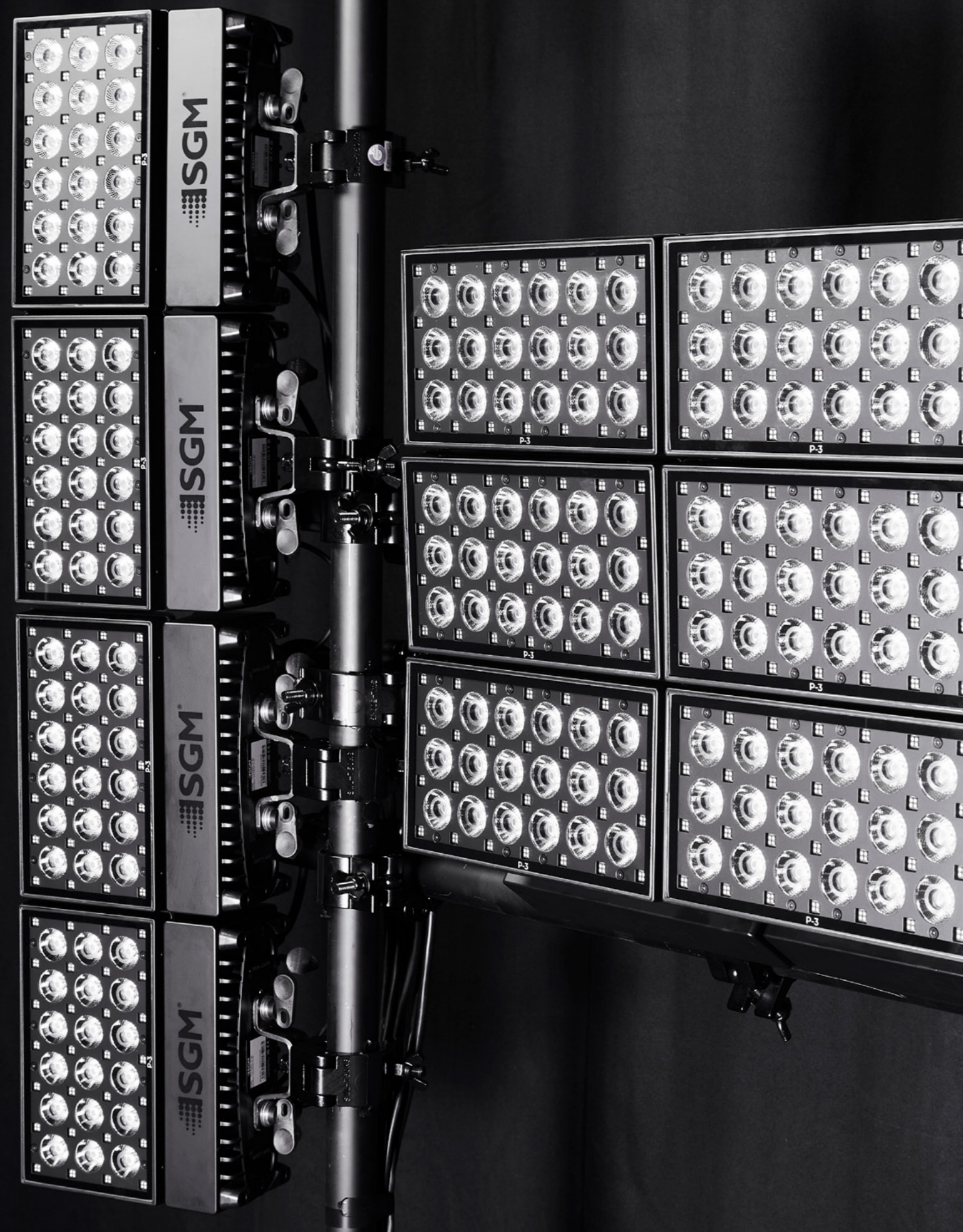

INCREDIBLE DESIGN FLEXIBILITY

The VP pixels in the P-3 Vision are identical to the pixels in the SGM Light VPL series and can run on the same data network. This allows P-3 Vision and VPL to be mixed and matched to provide multiple options and incredible design flexibility. Hybrid control of multiple data streams gives the production team incredible flexibility to integrate video and lighting.

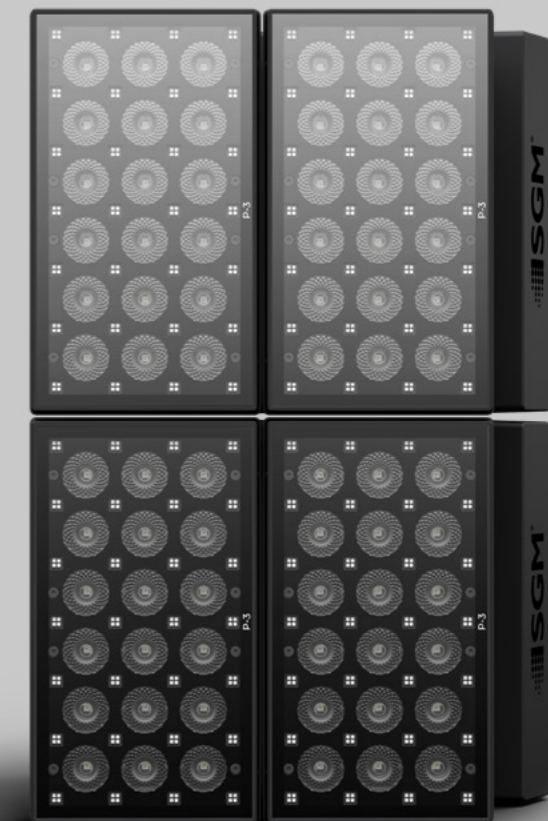
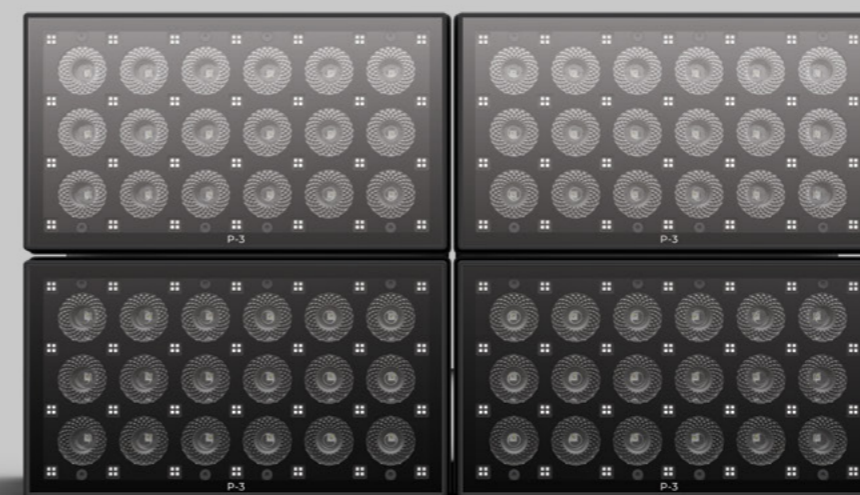

MAXIMUM POWER & EFFICIENCY



The P-3 Vision is the latest product to feature the **DynaMix®** Engine. **DynaMix®** is a scalable drive design which brings an unprecedented level of output to all new SGM Light products. LED engines with **DynaMix®** can utilize the full power capacity of a power source in any combination of drive channels. What does this mean? Essentially a huge boost in output. Not only in single channels of color, but also in mixed colors.

DynaMix® is made possible by using larger, more powerful LEDs than would normally be chosen at a given power rating. When combined with our active and passive **ThermalDrive®** cooling designs and the industry leading SGM Light calibration method, **TrueColor®**, the result is a completely optimized drive system which fully utilizes the maximum performance of every part of the fixture.



TruColor®
High Color Rendering
Enhanced Color Engine



ThermalDrive®
Advanced Temperature
Control Hybrid Cooling

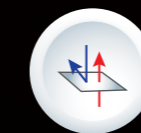

DryTech®
Integrated Dehumidification
Active Moisture Removal



DualSource®
2 Independent Light Sources
Optimized Power Management

VIDEO

CLICK ON THE PLAY BUTTON AND WATCH THE NEW P-3 VISION PRODUCT VIDEO

The video will be played in a
new tab in your browser.

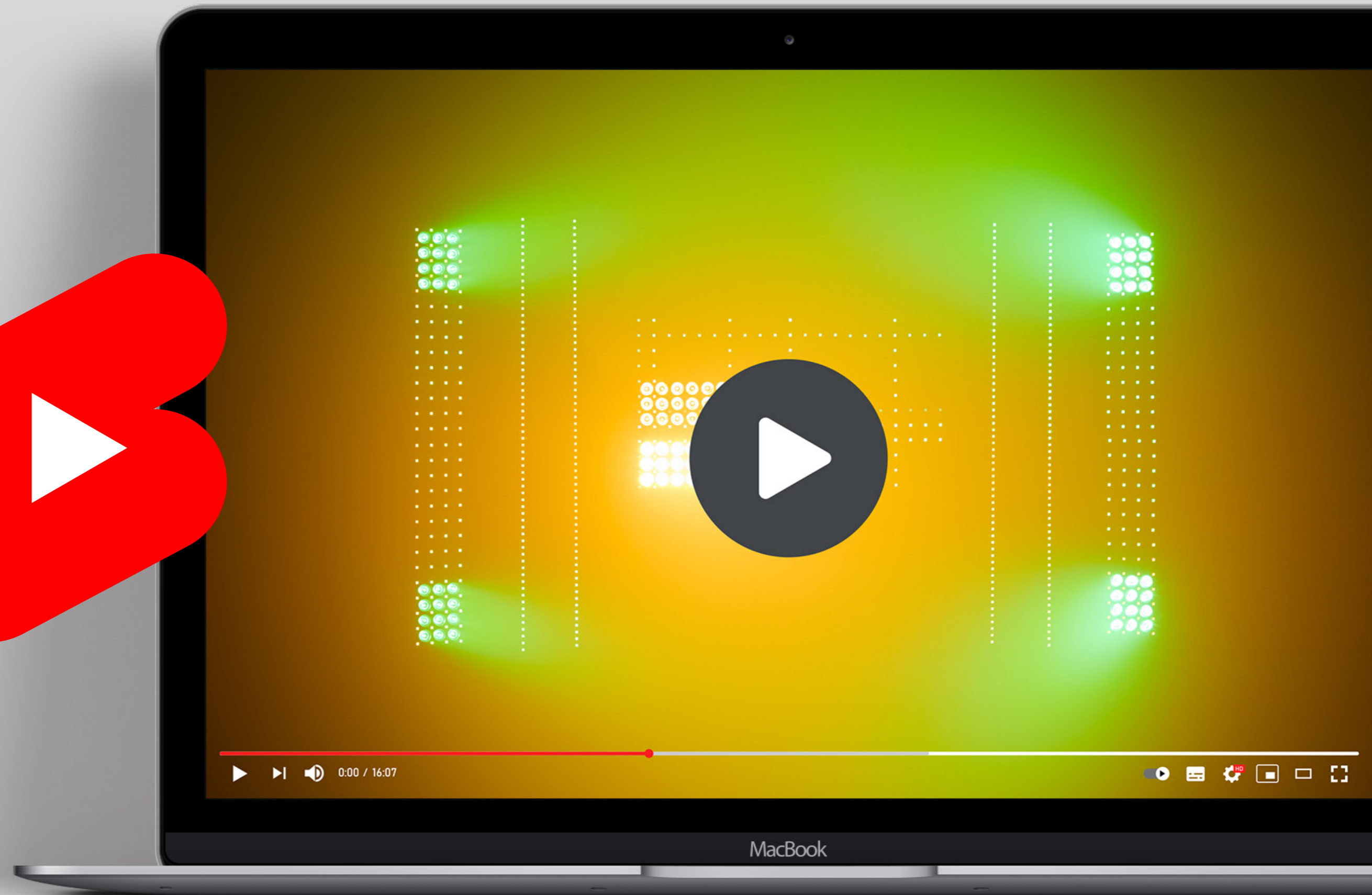

P-3 VISION AND TOURING VPL - COMBINED AS A SYSTEM

PIXEL SYSTEM

Pixels and Light combine with the new P-3 Vision and Touring VPL!

The VP pixels in the P-3 Vision are identical to the pixels in the VPL series and can run on the same data network. This allows P-3 Vision and VPL to be mixed and matched, providing incredible flexibility for your next show.



Alex Vargas - Train

Aarhus, Denmark

12 x P-3 Vision

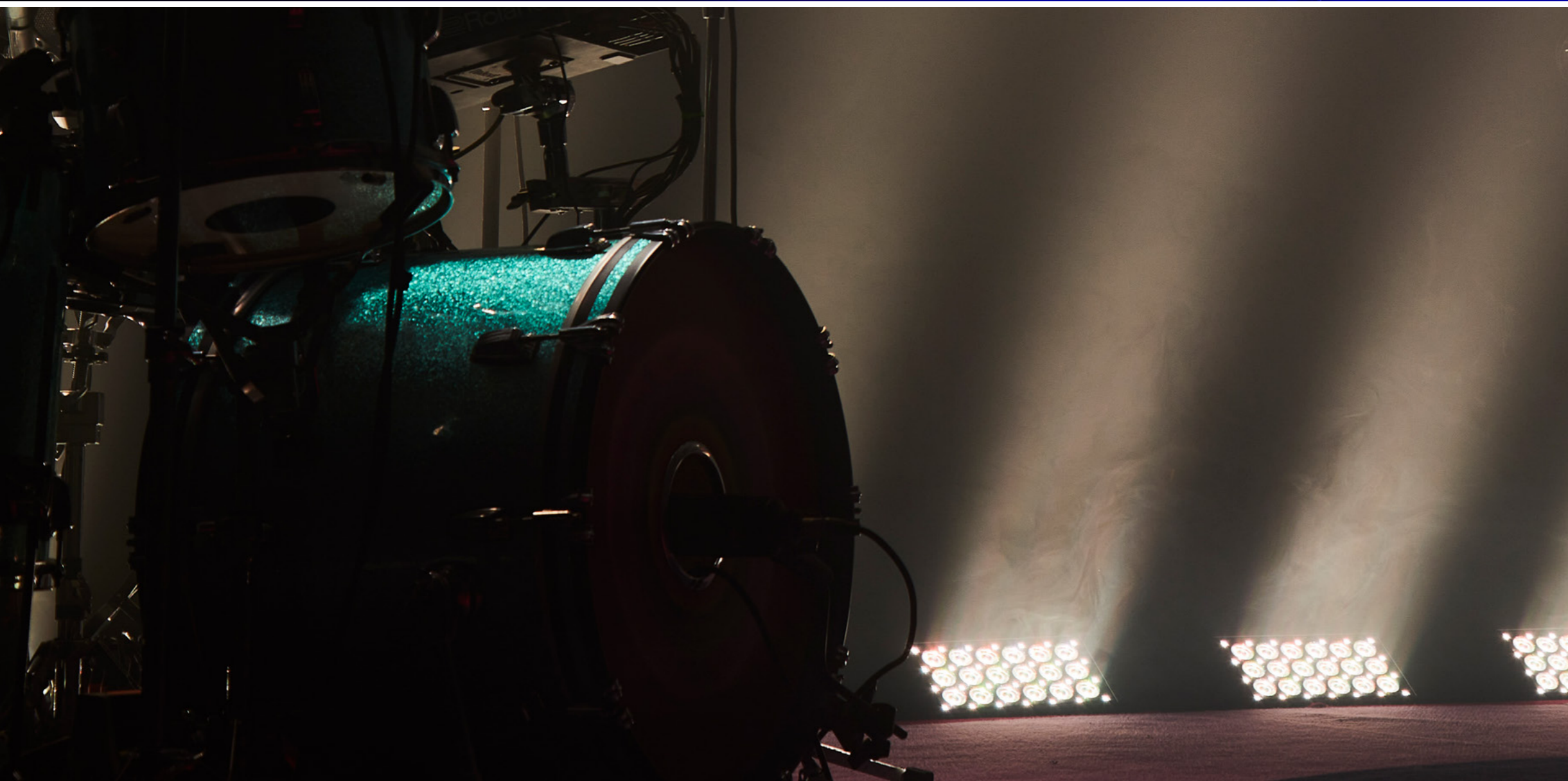

P-3 WASH

THE NEXT GENERATION OF SGM WASH FIXTURE

The P-3 Wash is part of the revolutionary family of SGM Light 3 Series fixtures. The 3 Series introduces numerous features and performance improvements which makes it unique amongst fixtures in this size class. Incorporating a >12,700 lumen illumination LED engine this compact powerhouse can be used as a color strobe or for illumination.

- Illumination LED Engine: 18 x 15W RGBW
- >12,700 peak lumens
- CTC: 2,000k - 10,000k
- Beam angle: 10°, 25° and 35°
- Power input: 100-277V
- Max. power: 340 Watts
- Control: sACN/Art-Net, wired/wireless DMX
- IP rating: IP66
- Active dehumidification
- Accessories: Filter frame



P-3 WASH

SPECIFICATIONS

OPTICAL DATA	
LED expected lifetime	50,000 hours
Lightsource	28 x RGB Clusters (112 total RGB LEDs) (Vision version only)
	18 x 15W RGBW LEDs
Native lens options	10°
	25°
	35°
Pixel size	6 x 6 mm Quad LED Pixel Clusters

PHOTOMETRIC	
Native beam angle(s)	10° (with 10° lens)
	25° (with 25° lens)
	35° (with 35° lens)
Preliminary light output all LEDs on - Vision	13000 lm
Preliminary light output all LEDs on - Wash	12700 lm
Preliminary light output all LEDs on - LM-79	12000 lm

PHYSICAL	
Color options	Black - RAL 9004
	White - RAL 9010
	Gray - RAL 7037
	Custom
Corrosion class	C5 (ISO 12944:2018)
IK rating	IK09
IP class	IP66
Lens material	Tempered glass front
Material	Aluminium
	PC/ASA
	Steel
Net dimensions L x H x W	290 x 252 x 124 mm
Net dimensions L x H x W (inches)	11.4 x 9.9 x 4.9 inches
Net weight	8.3 kg (18.3 lbs)

FEATURES	
Addressable pixels	28 (Vision version only)
Addressable segments	3
Color calibration	SGM proprietary with Dynamic Drive
Dehumidifier	Head
Goretex valve	Head / Base
Remote monitoring	Yes (Real Time)
Tilt locking system	Locking system with angle indicator
View angle	110°

ELECTRICAL	
Electrical protection	Overload protection with automatic recover
Input voltage, absolute max. rating	100 - 305 VAC; 50 / 60 Hz
Input voltage, nominal	115 - 277 VAC; 50 / 60 Hz
Max inrush current 230VAC	60 A
Max power consumption	360 W
Max power thru @ 100 V	16 A
Max power thru @ 230 V	14 A
Power factor	0.99 PF (230 V)
Power Supply Unit	High-efficiency electronic switch-mode
Standby power consumption	6 W

PROGRAMMING AND CONTROL	
16-bit control	Dimmer, Red, Green, Blue, White, pixels
Cabled DMX	5 pin XLR input/output
Data communication	100 Mb
DMX channels	7 - 128
DMX modes	9
Protocol	CRMX, W-DMX™ G2, W-DMX™ G3, W-DMX™ G4, W-DMX™ G4S
	USITT DMX512A
	RDM ANSI E1.20
	ArtNet (up to 120 Hz)
	sACN
Setting and addressing	OLED graphical display / 4 buttons
	RDM ANSI E1.20
Wireless DMX	Lumen Radio with RDM
Connections	
DMX data in/out	IP66 XLR 5-pin connector, Female
	IP66 XLR 5-pin connector, Male
Ethernet Connections	IP66 RJ45 Locking Chassis Mount Connections
Power	Power input connector & link-thru

THERMAL	
Cooling	Active, Forced Air, Temperature-regulated
Humidity (max.)	0,98
Temperature range, operating	-40°C to 50°C
Temperature range, start-up	-20°C to 50°C
Temperature range, storage	-40°C to 80°C
Total heat dissipation, max power	1228.3 BTU per hour
Total heat dissipation, standby	20.5 BTU per hour

INSTALLATION	
Mounting point	2 quarter-turn locking points for one Omega bracket
Orientation	Any
Safety features	Bottom mount for safety wire

INCLUDED ITEMS	
Included items	1 Omega bracket with quarter-turn fasteners

OPTIONAL ACCESSORIES	
Filters	SGM mechanical easy-fit spread angle filters and color frame
Beam Shaping	SGM 4-way and 8-way barndoors

ORDERING INFORMATION

FIXTURES

ORDERING NUMBER	PRODUCT
80032000	P-3 Vision, S, BL
80032100	P-3 Wash, S, BL
80232000	P-3 POI, S, BL
80232010	P-3 POI, S, Grey

ACCESSORIES

ORDERING NUMBER	PRODUCT
83061193	Filter Frame, P3 Series
83061194	Barndoor 4-way, BL, P-3
83061195	Anti-Glare Shield, P-3 Series

BRACKETS

ORDERING NUMBER	PRODUCT
83060602	Omega Bracket (Blk) with 1/4-turn fasteners
83061196	Arraying Bracket, BL, P-3

FLIGHT CASES

ORDERING NUMBER	PRODUCT
82051511	Flightcase for P-3, EU Variant
82051512	Flightcase for P-3, US Variant

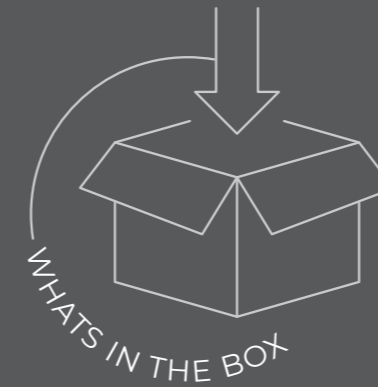

WHAT IS IN THE BOX

- Fixture
- 1 Omega bracket with quarter turn fasteners
- Printed leaflet with safety instructions
- 1 IP66 power cable

IMPORTANT NOTES

Please note that accessories such as barndoors or filters are ordered separately.

DEVELOPED, MANUFACTURED, AND TESTED IN DENMARK



- Premium user-centered design
- Flexible manufacturing process
- Short reaction time; faster deliveries
- Integrated support (R&D / production / after-sales)



Our approach to sustainability follows best practice from the United Nations Sustainable Development Goals, the Greenhouse Gas Protocol, and ISO standards. We audit our activities with the help of 3rd parties to provide reliable and actionable data on our activities.



IP66

**UK
CA**

CE



RoHS

WWW.SGMLIGHT.COM